

B44 Series

SIM to SIM/Full Size SIM Extender

Product > Extender Board > B44 Series

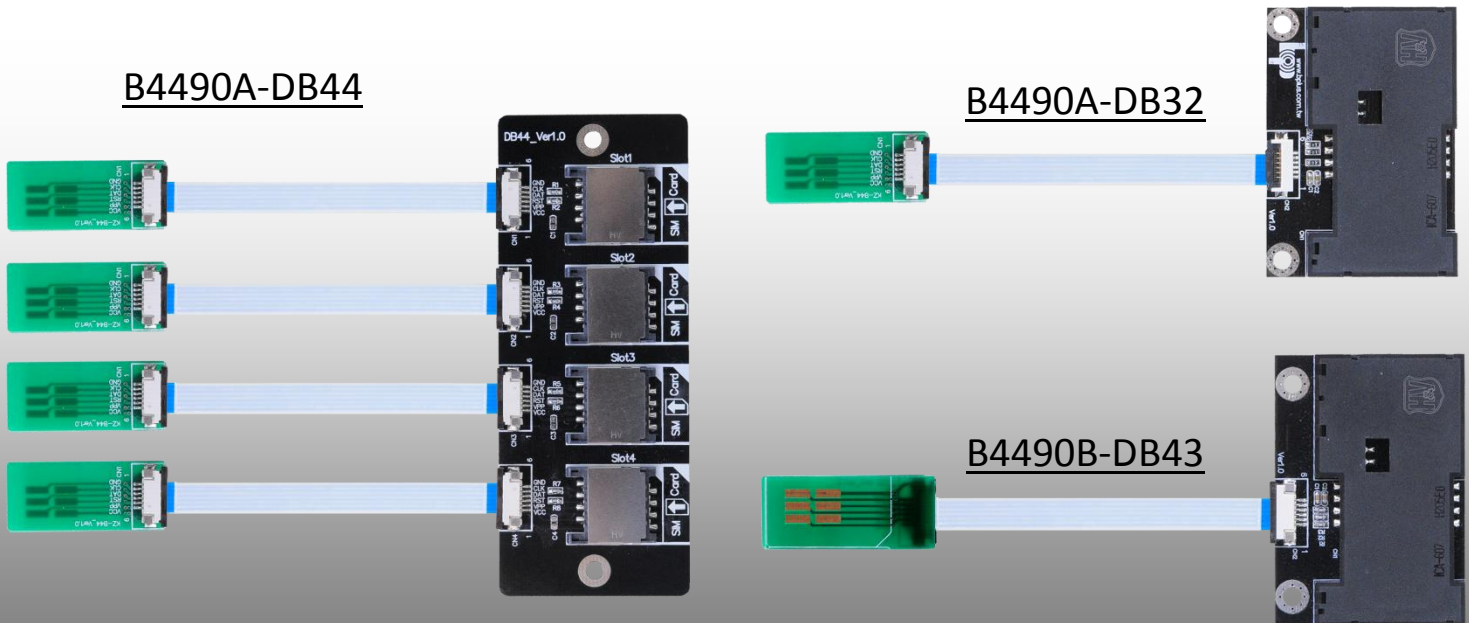

First Impression

B44 Series SIM to SIM or Full Size SIM card Extender is a debug and test tool. Design the FPC cable for flexible use.

It allows a SIM Card to be extended from the host slot for SIM interface.

It's especially designed to save valuable labor and time in the production environment. The SIM extender is designed to minimize the signal degradation effects of the extender by proven design techniques.

It's also a powerful tool for engineers, or use for mobile phone SIM test protection.

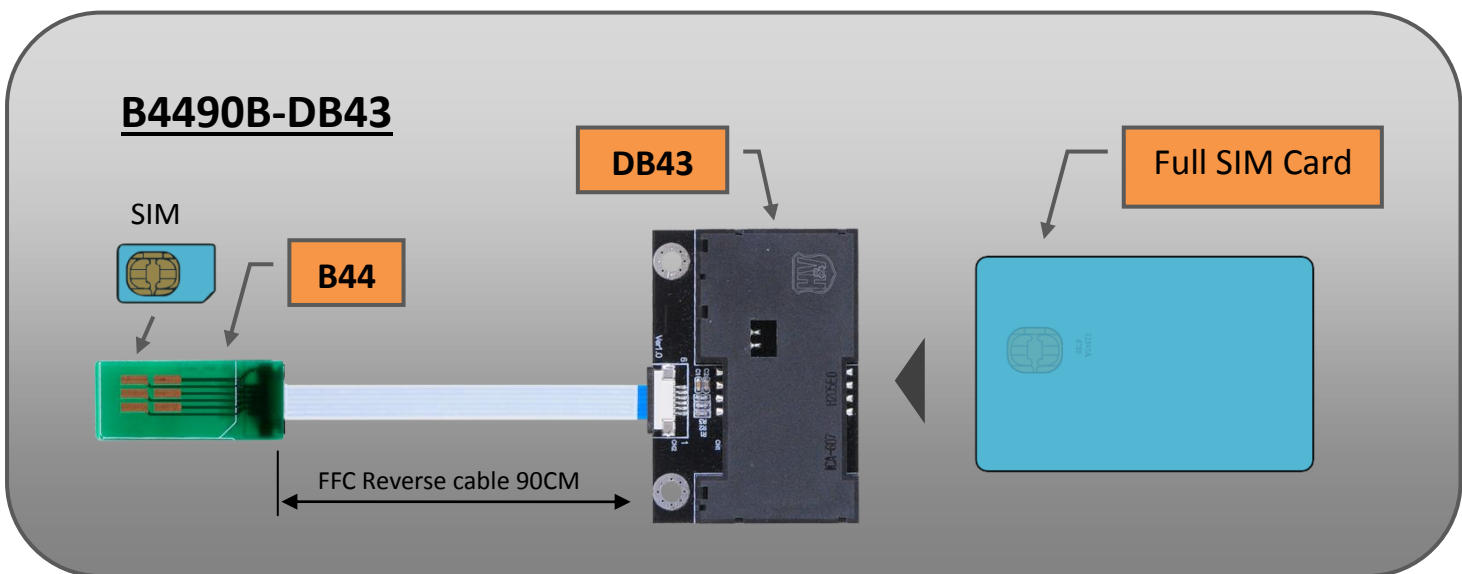
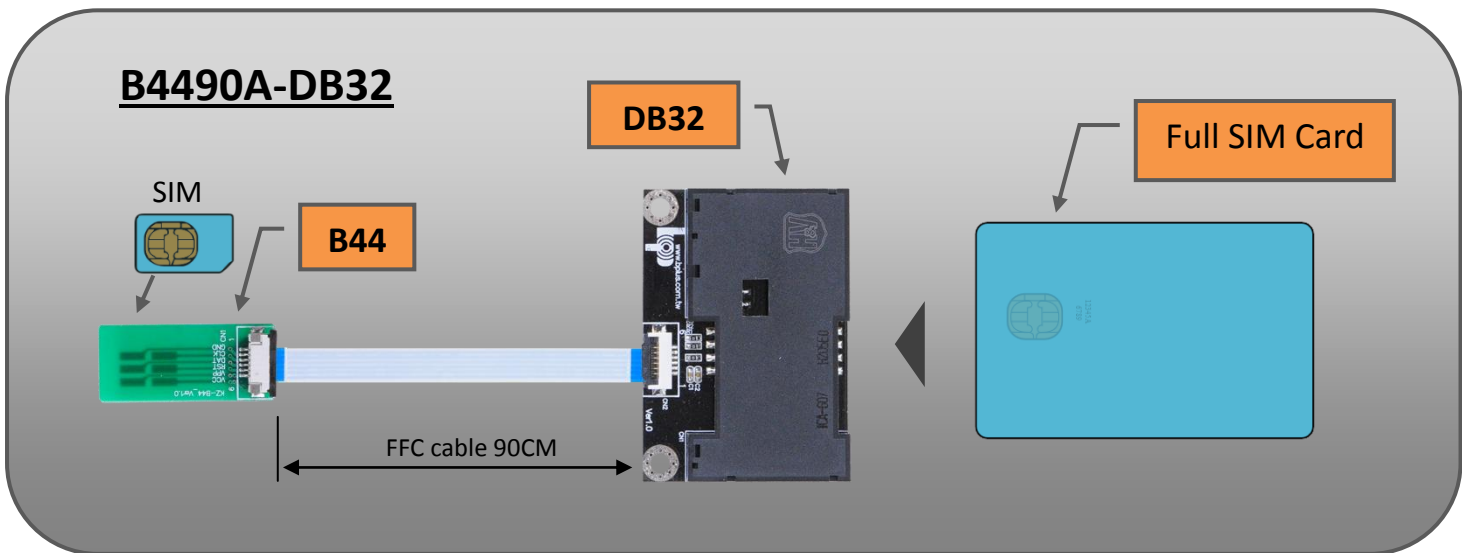
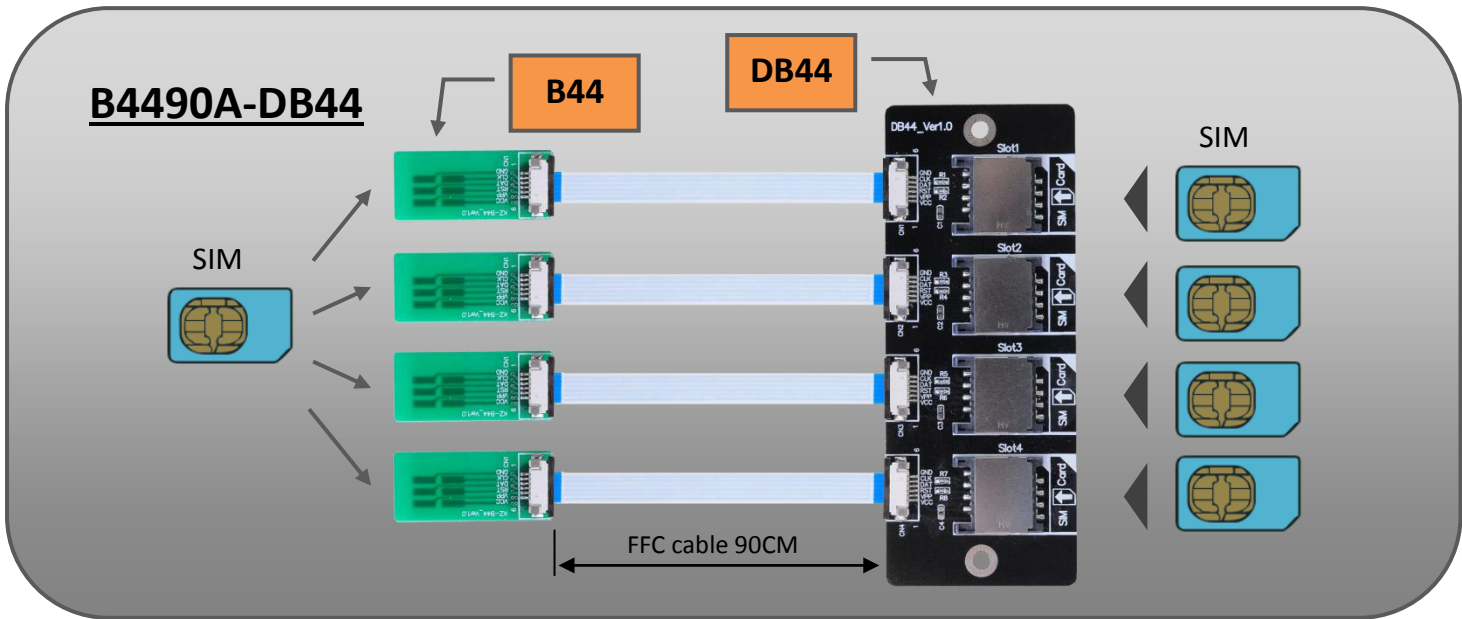

B4490A-DB44

Package Content



B44 (SIM board) x1

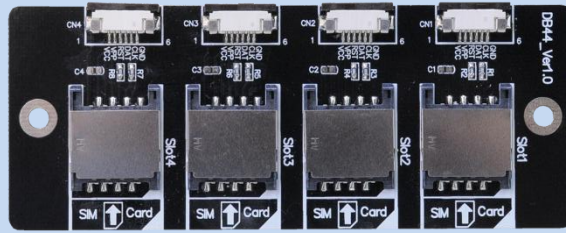

DB44 (Quad SIM daughter board) x1



FFC1006P-090A (FFC cable 90cm) x1

B4490A-DB32

Package Content



B44 (SIM daughter board) x1

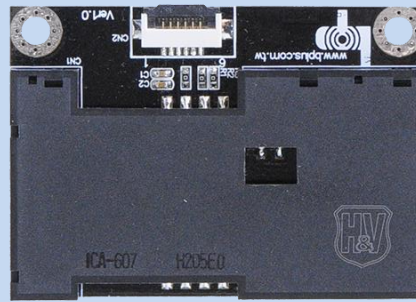

DB32

(full size SIM daughter board) x1

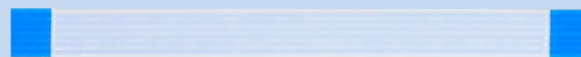

FFC1006P-090A (FFC cable 90cm) x1

B4490B-DB43

Package Content



B44 (SIM daughter board) x1

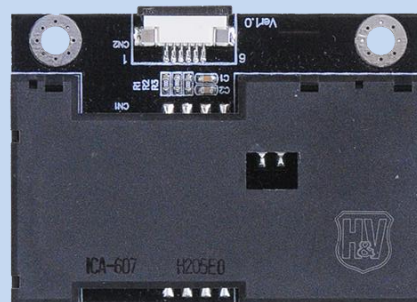





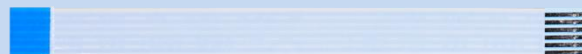

DB43

(full size SIM daughter board) x1

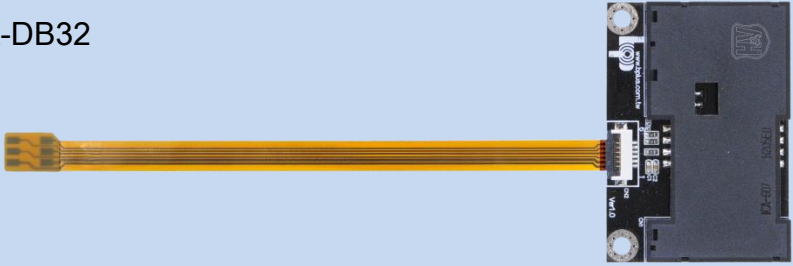

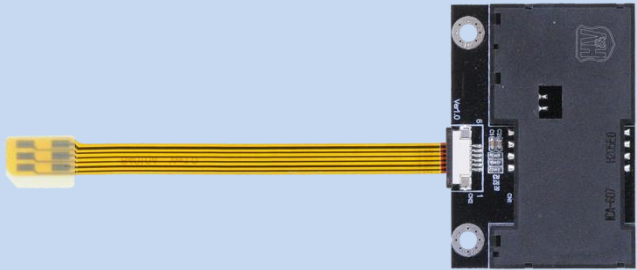
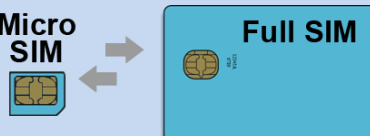
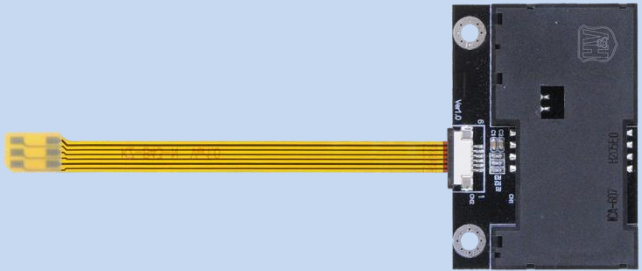
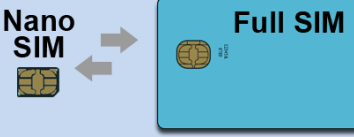
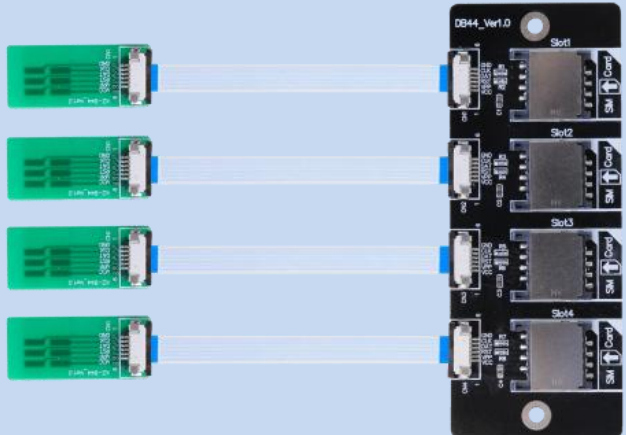
FFC1006P-090B (FFC Reverse cable 90cm) x1

B32 / B40 / B43 / B44 / B45 / B46 series Comparison

<p>B3214A-DB32</p> 	<p>for iPhone5 / iPhone5S(c) for NEW iPad / iPad-mini</p> 
<p>B4010A-DB43</p> 	<p>for 三星 Galaxy</p> 
<p>B4310A-DB43</p> 	
<p>B4490A-DB44</p> 	
<p>B4490A-DB32</p> 	

B4490B-DB43

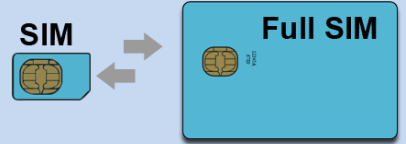

B4516A-DB43

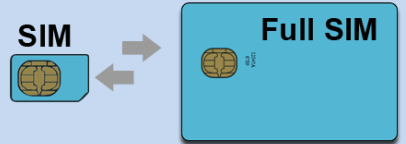

B4616A-DB32



For Apple iPhone4

